

Scarborough 160 40 (120 1/8"x191 3/4")

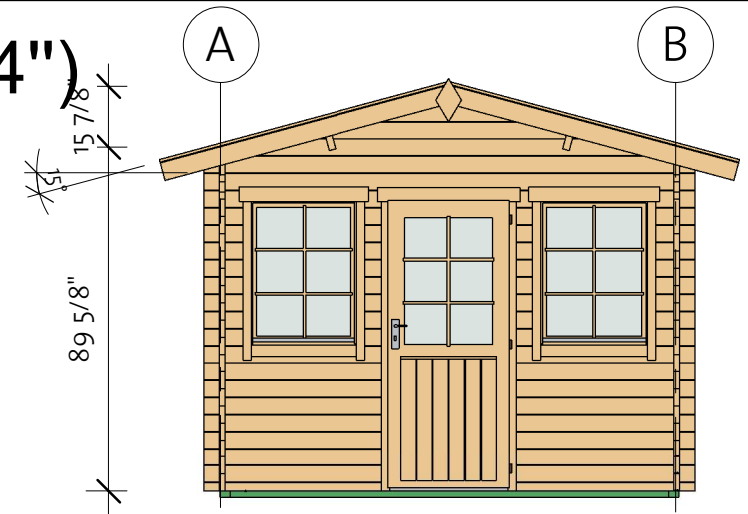

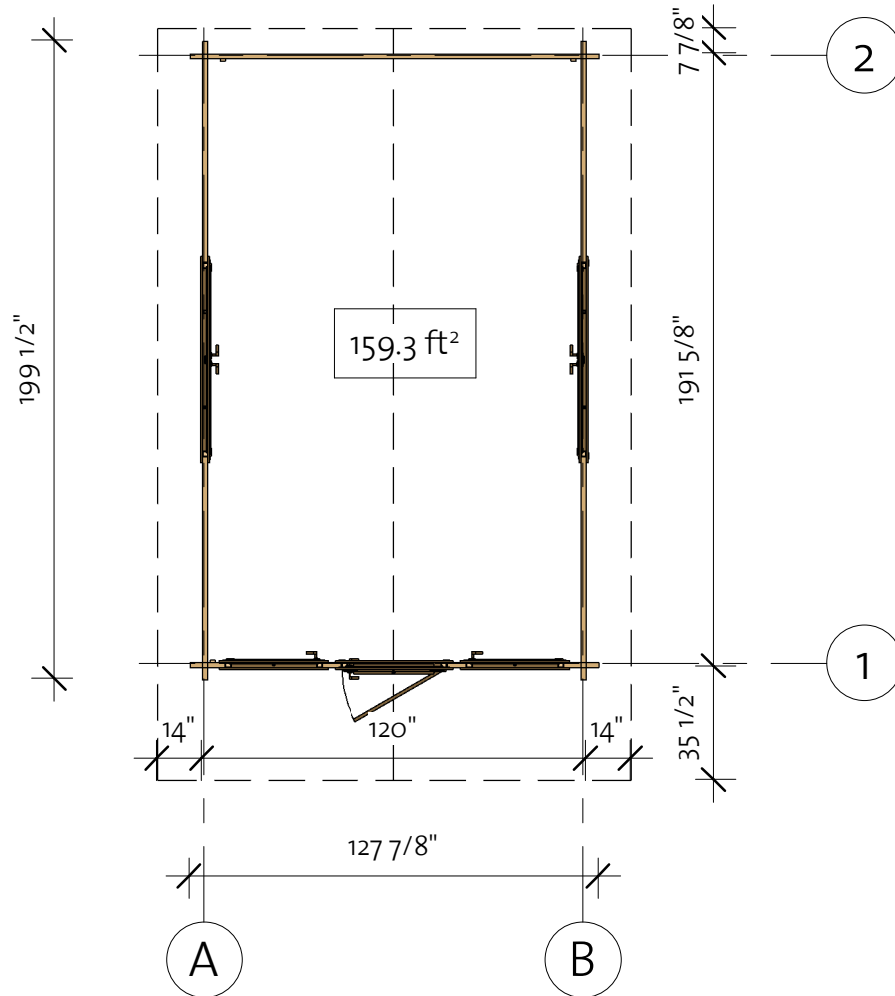

EZ Log Structures
Do-It-Yourself Building Kits

Scarborough 160 40 (120 1/8"x191 3/4")

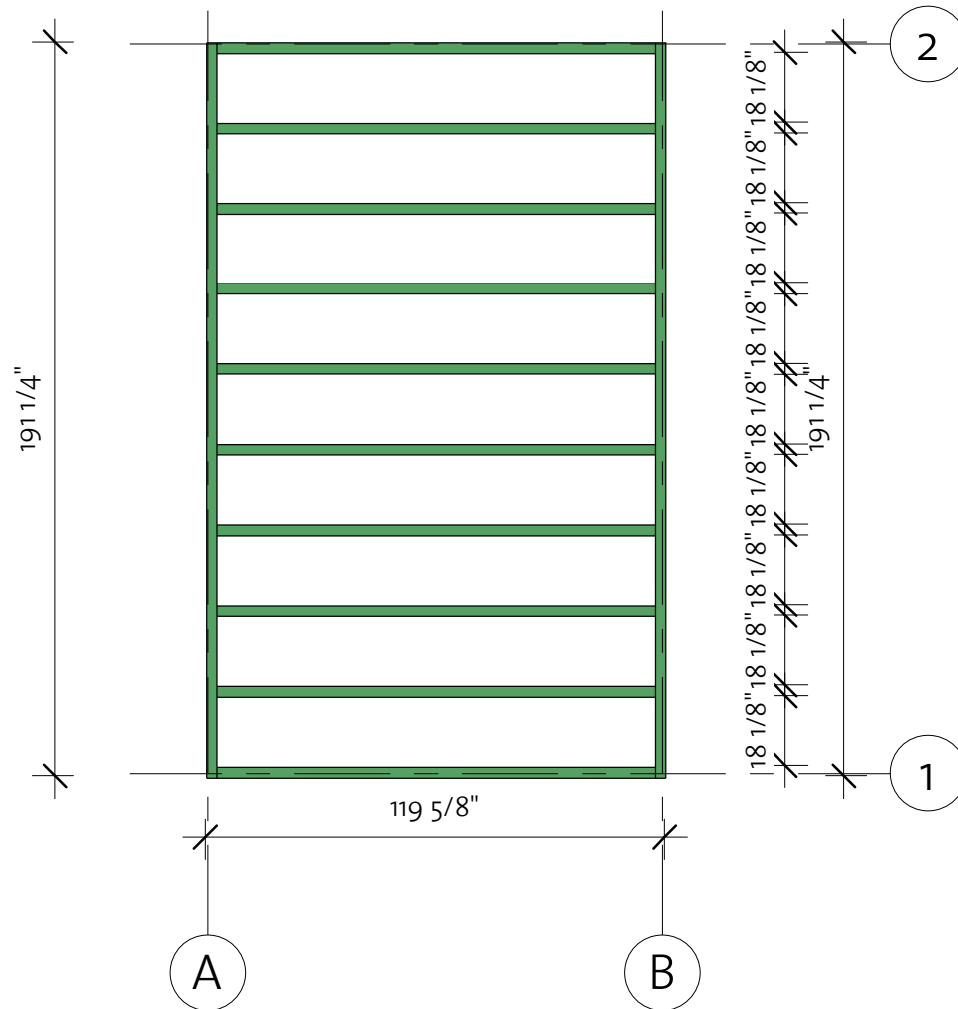
Foundation





Impregnated foundation beams				
Mark	Type	Profile	Count	Length
IFB1	IFB 70x40		10	114 1/8"
IFB2	IFB 70x40		2	191 1/4"

Scarborough 160 40 (120 1/8"x191 3/4")

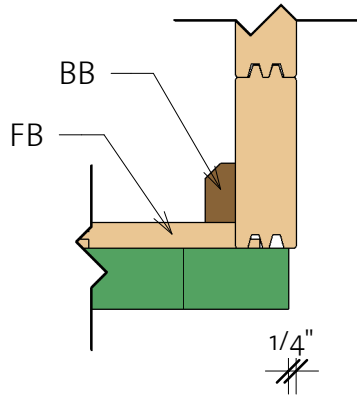
Floor Plan ① Baseboard



Floor Schedule				
Mark	Type	Profile	Count	Length
FB	FB 17x114		27	188 3/8"
BB1	BB 20X40		2	122"
BB2	BB 20X40		2	192 7/8"

92309191_231002

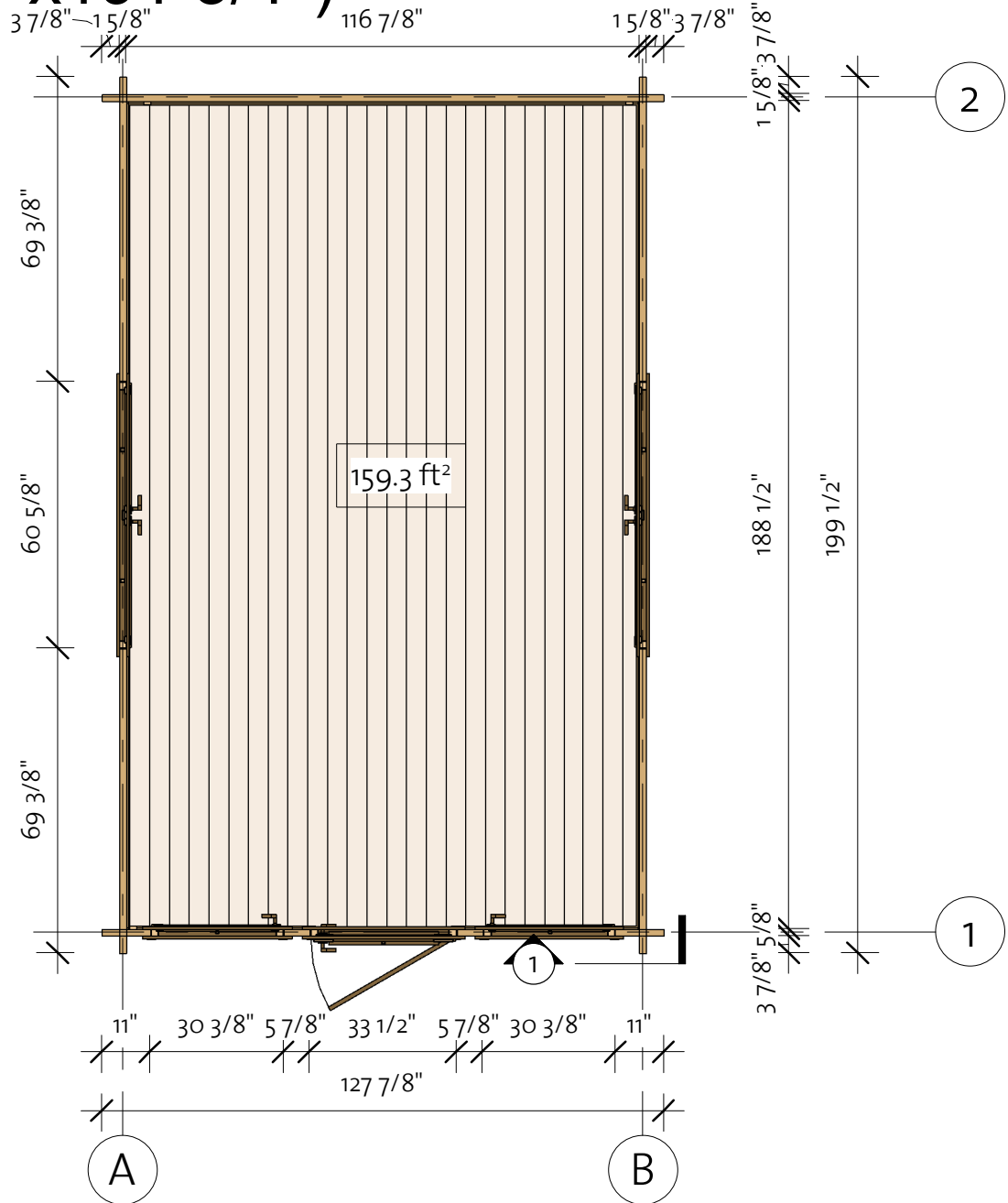

Scarborough 160 40 (120 1/8"x191 3/4")

Wall 1

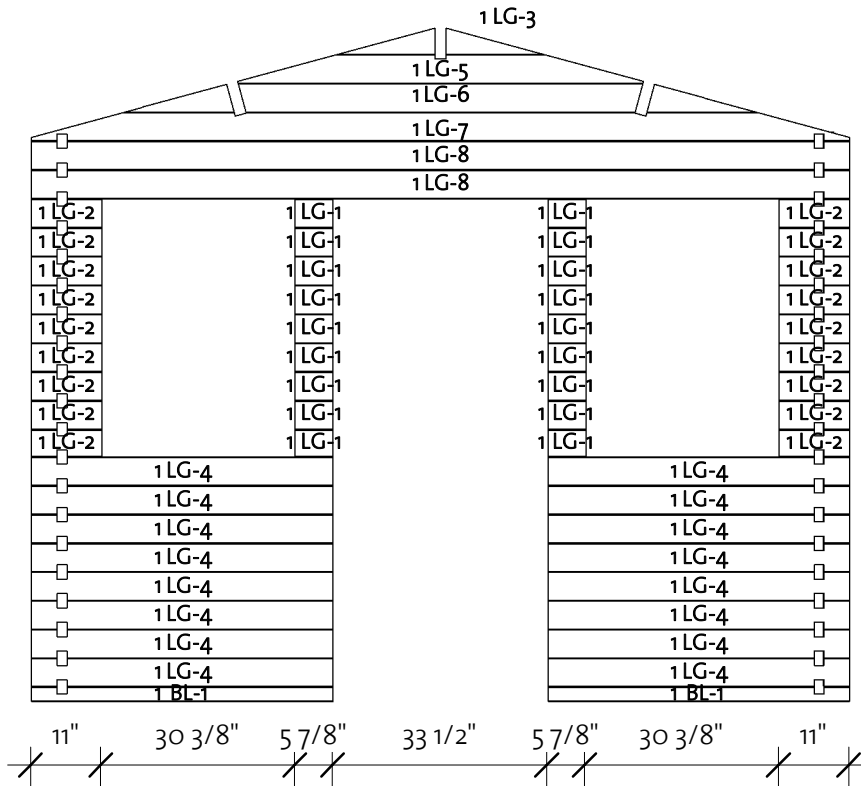
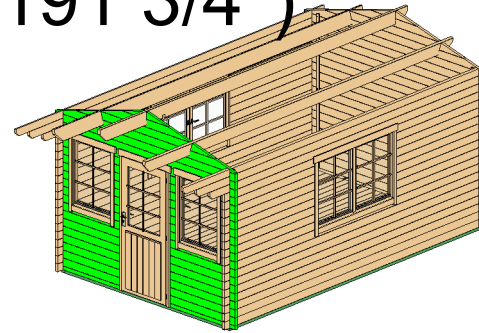



Wall 1			
Mark	Profile	Count	Cut Length

1BL-1	40X57	2	47 1/4"
1LG-1	40X114	18	5 7/8"
1LG-2	40X114	18	11"
1LG-3 *	40X114	1	32 3/8"
1LG-4	40X114	16	47 1/4"
1LG-5 *	40X114	1	63 1/4"
1LG-6 *	40X114	1	99"
1LG-7 *	40X114	1	127 7/8"
1LG-8	40X114	2	127 7/8"

* Gable - delivered premounted

Log Profile Wall 1	
Profile	Profile

40X57	
40X114	

Scarborough 160 40 (120 1/8"x191 3/4")

Wall 2

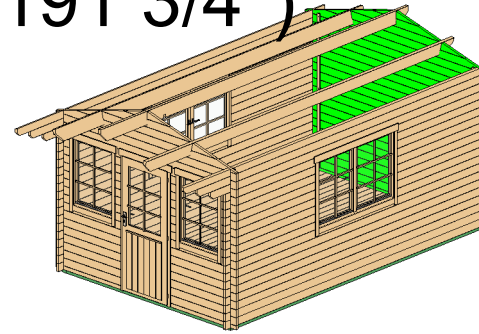

Wall 2			
Mark	Profile	Count	Cut Length

2BL-1	40X57	1	127 7/8"
2LG-1*	40X114	1	32 3/8"
2LG-2*	40X114	1	63 1/4"
2LG-3*	40X114	1	99"
2LG-4*	40X114	1	127 7/8"
2LG-5	40X114	19	127 7/8"

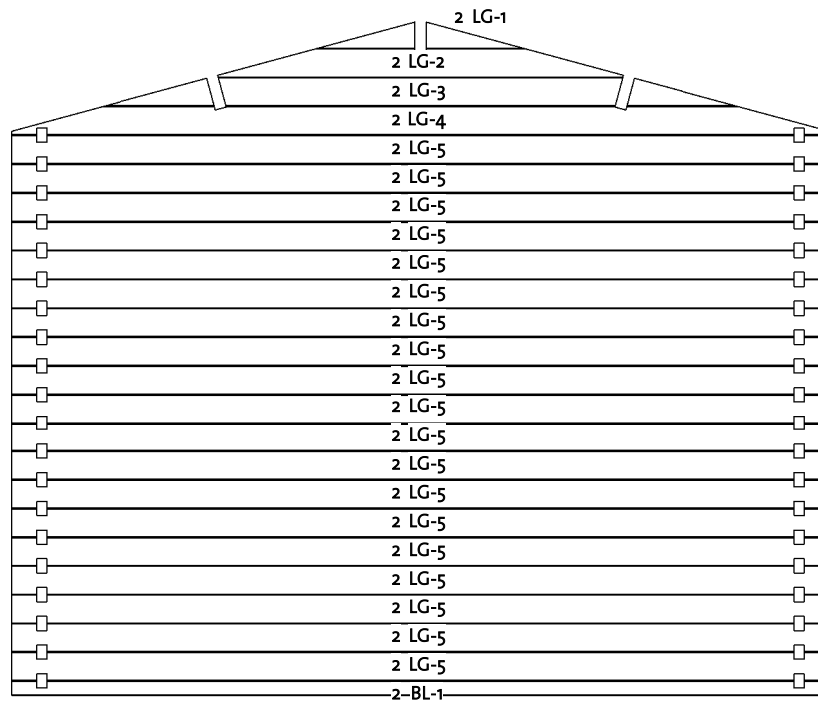

* Gable - delivered premounted

Log Profile Wall 2	
Profile	Profile

40X57	
40X114	

Scarborough 160 40 (120 1/8"x191 3/4")

Wall A

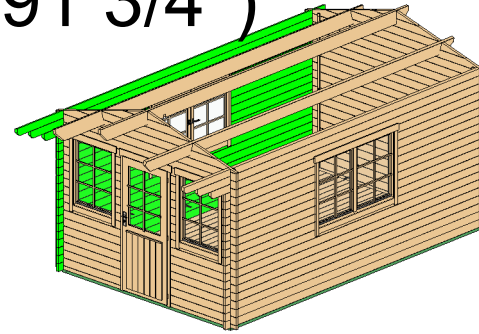

Wall A			
Mark	Profile	Count	Cut Length
ALG-1	40X114	18	69 1/2"
ALG-2	40X114	1	220 7/8"
ALG-3	40X114	8	199 1/2"
ALG-4	40X114	1	210 5/8"
ATL-1	40X114	1	235"

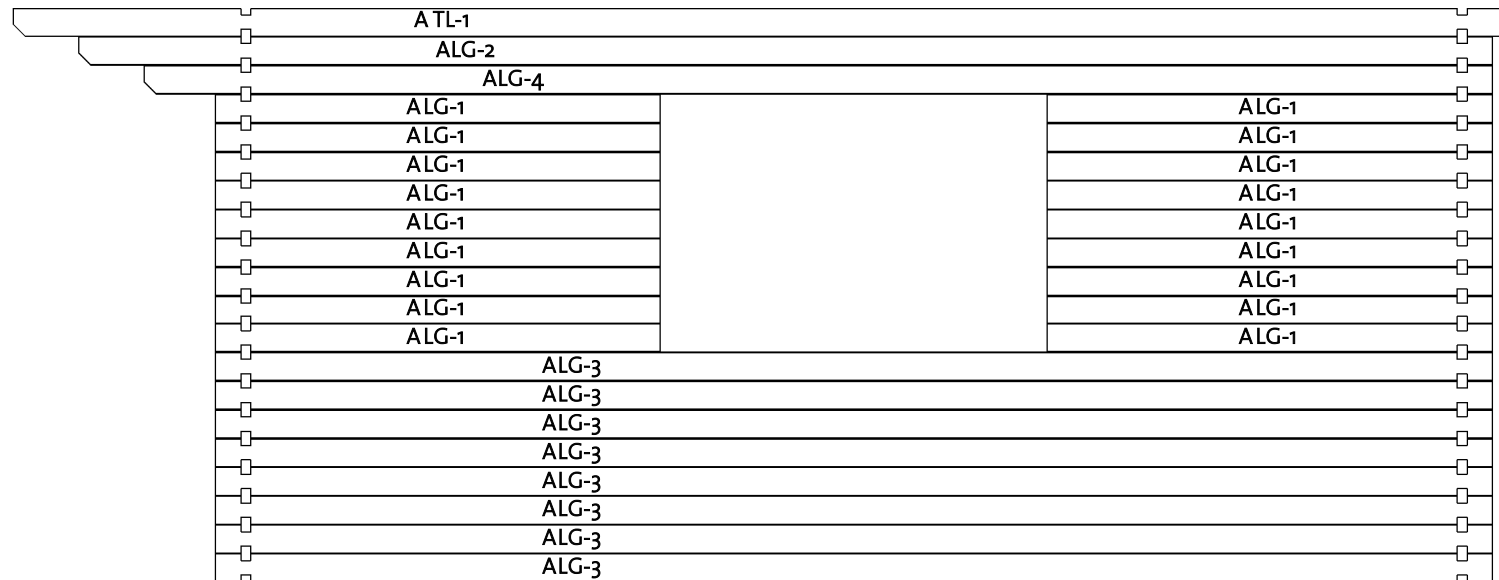

Log Profile Wall A	
Profile	Profile

40X114	
40X114	

Scarborough 160 40 (120 1/8"x191 3/4")

Wall B

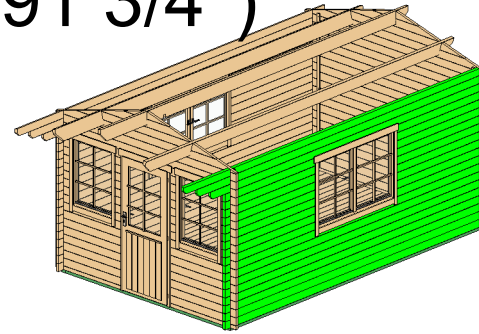

Wall B			
Mark	Profile	Count	Cut Length
BLG-1	4OX114	18	69 1/2"
BLG-2	4OX114	1	220 7/8"
BLG-3	4OX114	8	199 1/2"
BLG-4	4OX114	1	210 5/8"
BTL-1	4OX114	1	235"

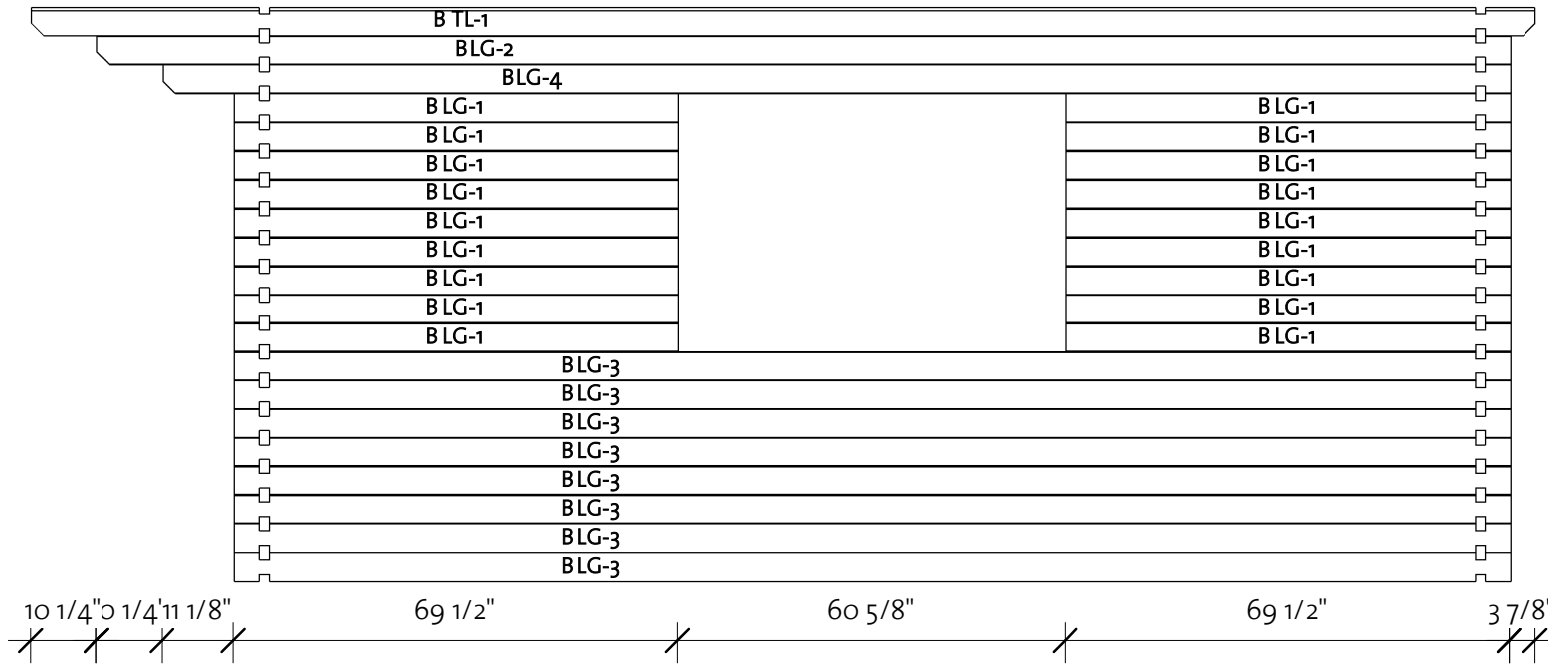





Log Profile Wall B	
Profile	Profile

4OX114	
4OX114	

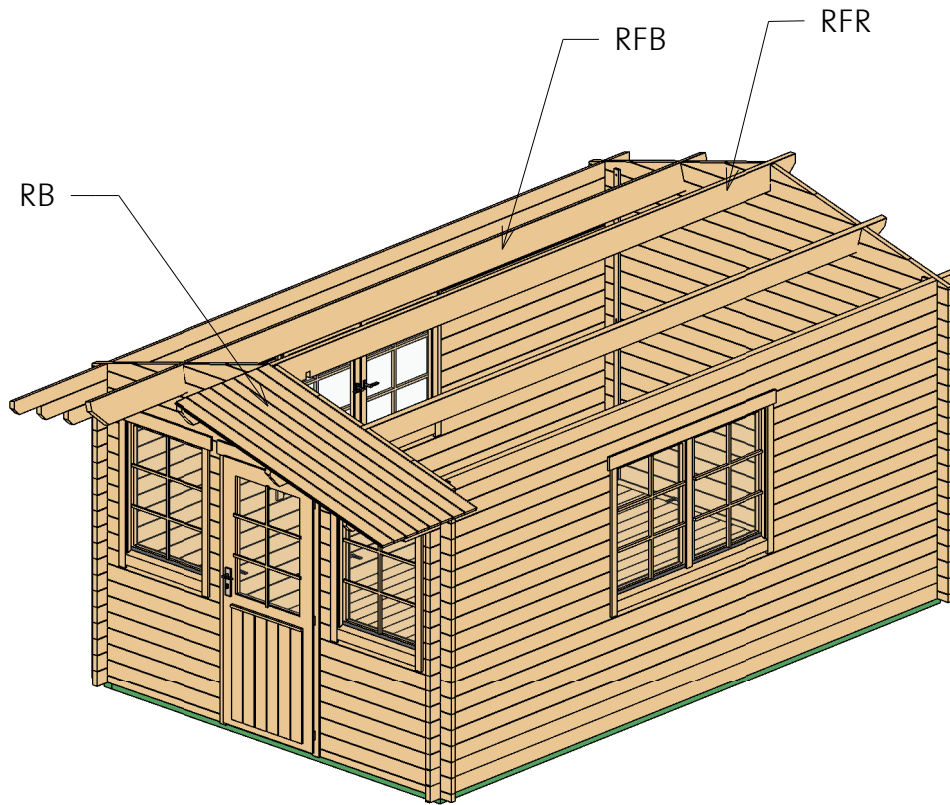
Scarborough 160 40 (120 1/8"x191 3/4")

Roof 1



Roof				
Mark	Type	Profile	Count	Length
RFR	Ridge 45x195		1	235"
RFB	Beam 45x195		2	235"
RB	17x114		108	76 3/8"

Scarborough 160 40 (120 1/8"x191 3/4")

Roof 2

② Facia

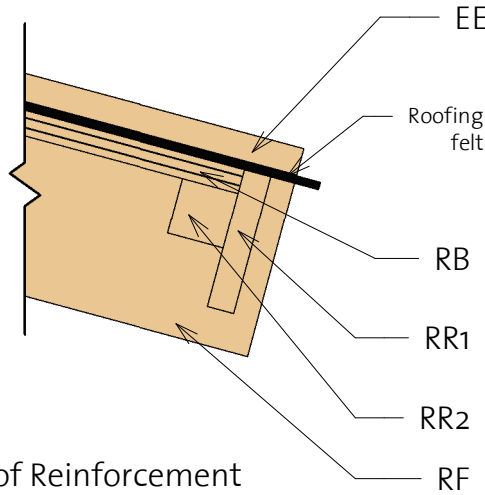
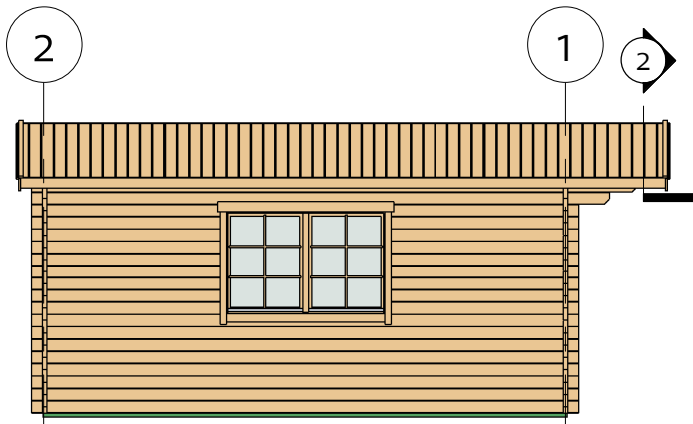

③ Roof Reinforcement

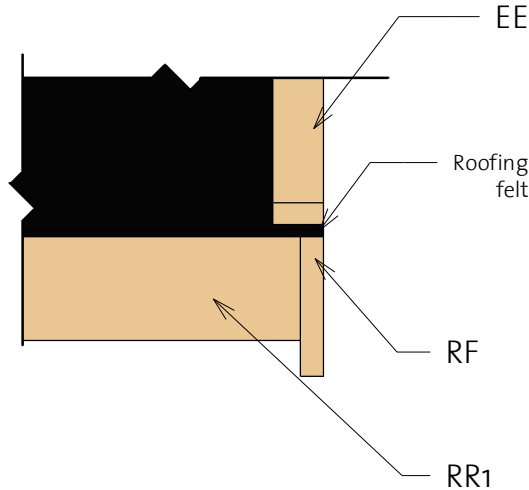
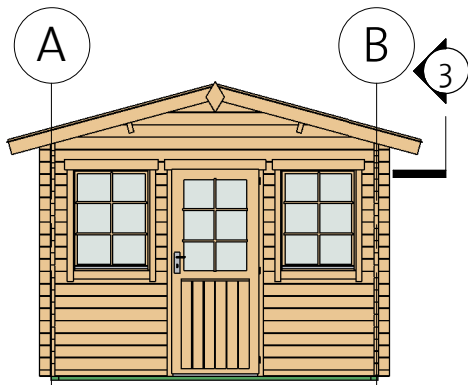

Fascia Schedule

Mark	Type	Profile	Count	Length
EE	Eave Edging 18x40		4	78"
RF	Roof Fascia 18x120		4	78"
RR1	Roof reinforce ment 18x95		2	235"
RR2	Roof reinforce ment 38x38		2	235"

Scarborough 160 40 (120 1/8"x191 3/4")

Extras

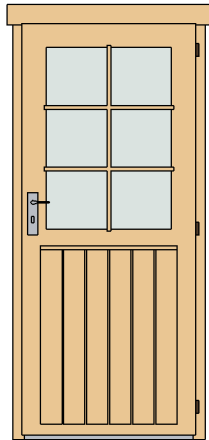

Door Schedule				
Model	Type	Width	Height	Count
CD4R	Classic door 4 right	33 1/8"	77"	1
DCB6	Door Crossbar 6	--	--	0"

Type	Count	Length
------	-------	--------







Windboard 18x40	4	86 5/8"
-----------------	---	---------

Type	Count
------	-------

Romb	2
------	---

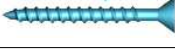

Fasteners/Extras

Hitblock	300-400 mm		
Bolts	M8x70		12
Screws	5,0 x 70		15
Nails	1,4 x 40		30
Screws	6,0 x 140		45
Screws	4,0 x 40		650

Window Schedule

Mark	Type	Width	Height	Count
CDW1	Classic double window 1	60 1/4"	39"	2
CW1L	Classic window 1 left	30 1/8"	39"	1
CW1R	Classic window 1 right	30 1/8"	39"	1
WCB6	Windows Crossbar 6	--	--	6

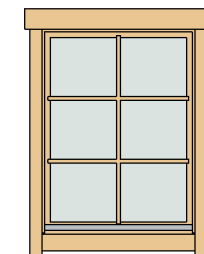
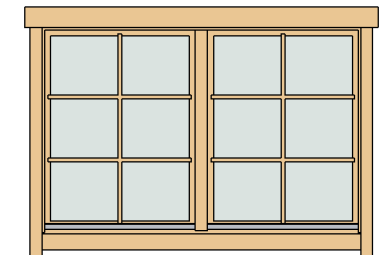



Scarborough 160 40 (120 1/8"x191 3/4")

List of all items 1

Impregnated foundation beams

Mark	Type	Profile	Count	Length
------	------	---------	-------	--------

IFB1	IFB 70x40		10	114 1/8"
IFB2	IFB 70x40		2	191 1/4"

Floor Schedule



Mark	Type	Profile	Count	Length
------	------	---------	-------	--------

FB	FB 17x114		27	188 3/8"
----	-----------	---	----	----------

BB1	BB 20x40		2	122"
BB2	BB 20x40		2	192 7/8"





Roof

Mark	Type	Profile	Count	Length
------	------	---------	-------	--------

RFR	Ridge 45x195		1	235"
RFB	Beam 45x195		2	235"
RB	17x114		108	76 3/8"

Fascia Schedule

Mark	Type	Profile	Count	Length
------	------	---------	-------	--------

EE	Eave Edging 18x40		4	78"
RF	Roof Fascia 18x120		4	78"
RR1	Roof reinforce ment 18x95		2	235"
RR2	Roof reinforce ment 38x38		2	235"

Scarborough 160 40 (120 1/8"x191 3/4")

List of all items 2

Wall 1			
Mark	Profile	Count	Cut Length

1BL-1	40X57	2	47 1/4"
1LG-1	40X114	18	5 7/8"
1LG-2	40X114	18	11"
1LG-3 *	40X114	1	32 3/8"
1LG-4	40X114	16	47 1/4"
1LG-5 *	40X114	1	63 1/4"
1LG-6 *	40X114	1	99"
1LG-7 *	40X114	1	127 7/8"
1LG-8	40X114	2	127 7/8"

Wall 2			
Mark	Profile	Count	Cut Length

2BL-1	40X57	1	127 7/8"
2LG-1 *	40X114	1	32 3/8"
2LG-2 *	40X114	1	63 1/4"
2LG-3 *	40X114	1	99"
2LG-4 *	40X114	1	127 7/8"
2LG-5	40X114	19	127 7/8"

* Gable - delivered premounted



Wall A			
Mark	Profile	Count	Cut Length

ALG-1	40X114	18	69 1/2"
ALG-2	40X114	1	220 7/8"
ALG-3	40X114	8	199 1/2"
ALG-4	40X114	1	210 5/8"
ATL-1	40X114	1	235"

Wall B			
Mark	Profile	Count	Cut Length

BLG-1	40X114	18	69 1/2"
BLG-2	40X114	1	220 7/8"
BLG-3	40X114	8	199 1/2"
BLG-4	40X114	1	210 5/8"
BTL-1	40X114	1	235"

Log profiles	
Profile	Profile

40X57	
40X114	

Log profiles	
Profile	Profile

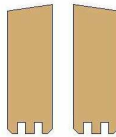
40X114	
--------	--