

Kansas 40 (137 3/4" x 167 3/8")

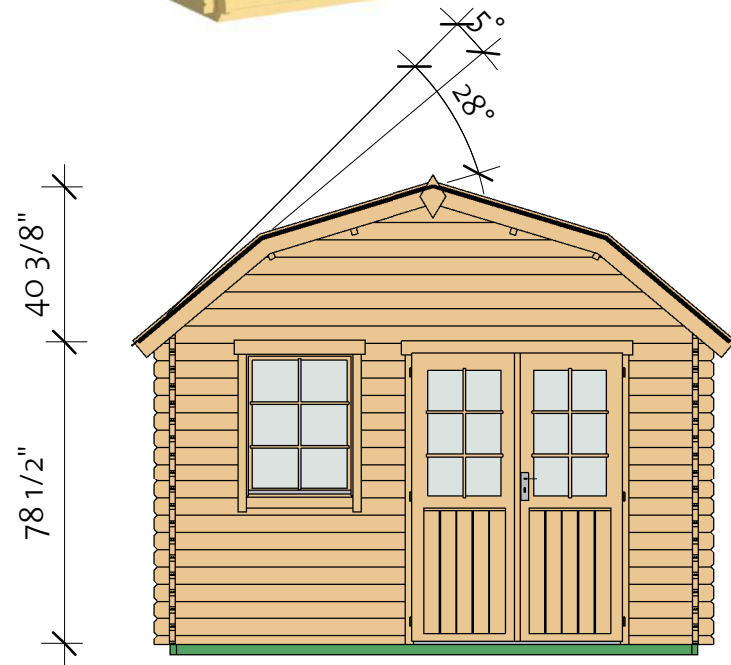

Kansas 40 (137 3/4" x 167 3/8")

Foundation

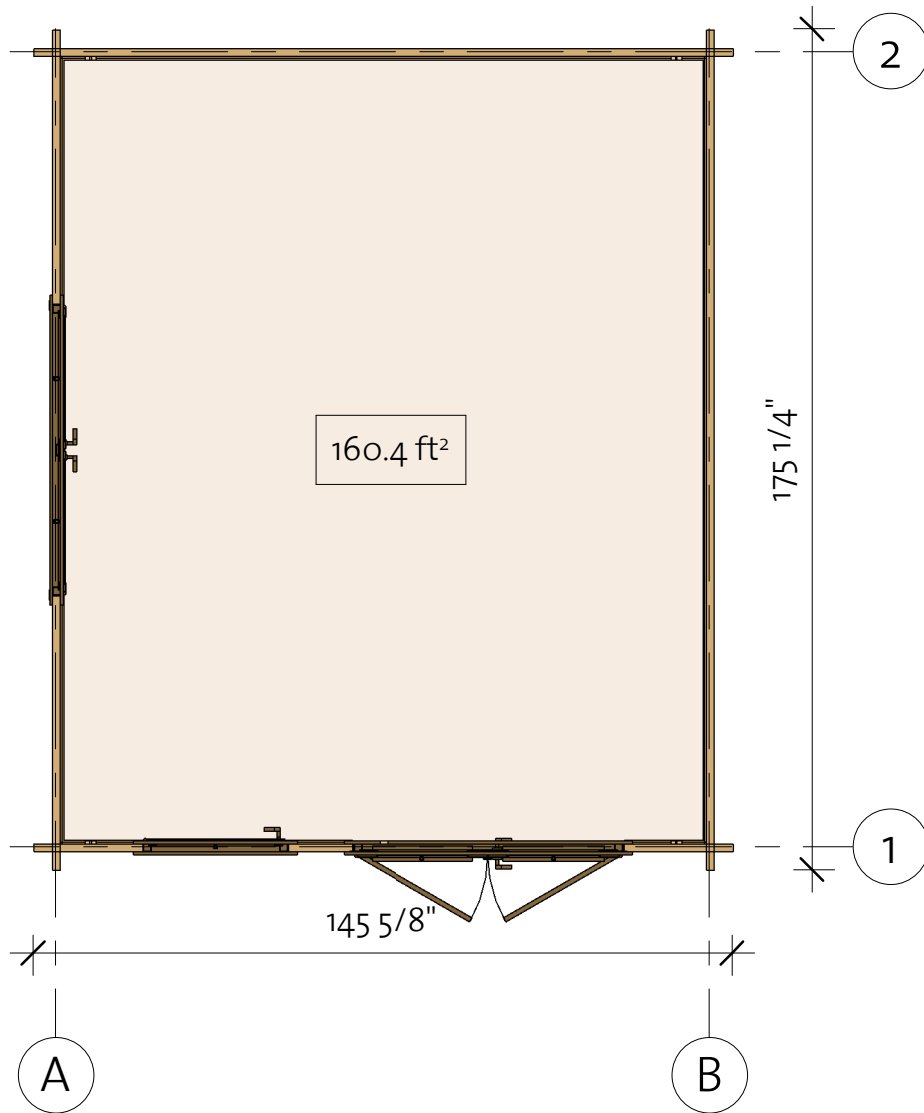
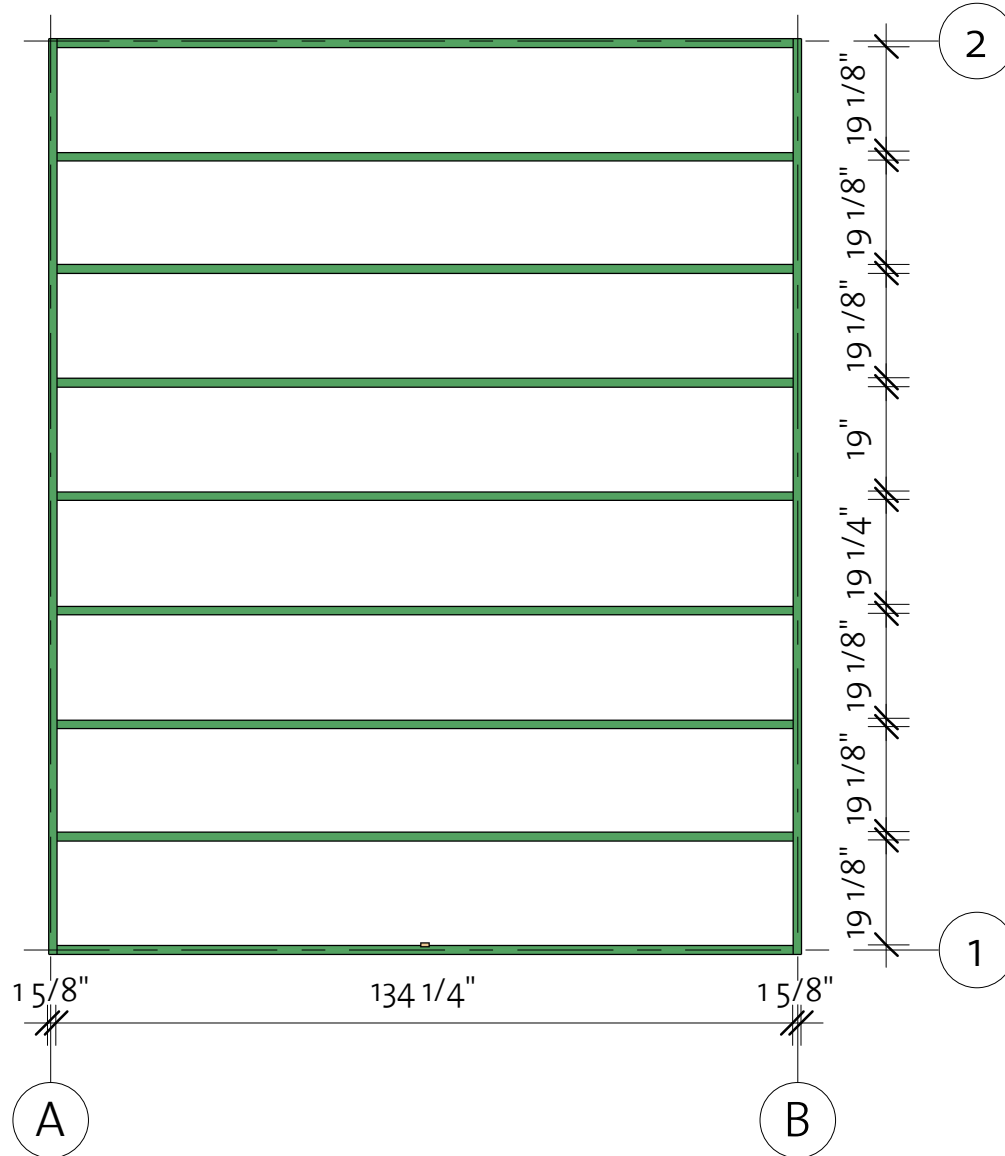

Impregnated foundation beams				
Mark	Type	Profile	Count	Length

IFB1	IFB 40x70		2	166 7/8"
IFB2	IFB 40x70		9	134 1/4"

Kansas 40 (137 3/4" x 167 3/8")

Floor Plan

① Baseboard

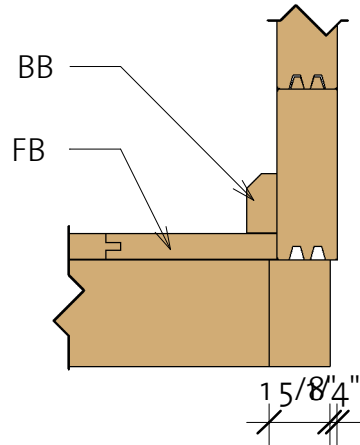

Floor Schedule				
Mark	Type	Profile	Count	Length
FB	FB 17x114		31	164"
BB1	BB 20x40		2	167 3/8"
BB2	BB 20x40		2	137 3/4"

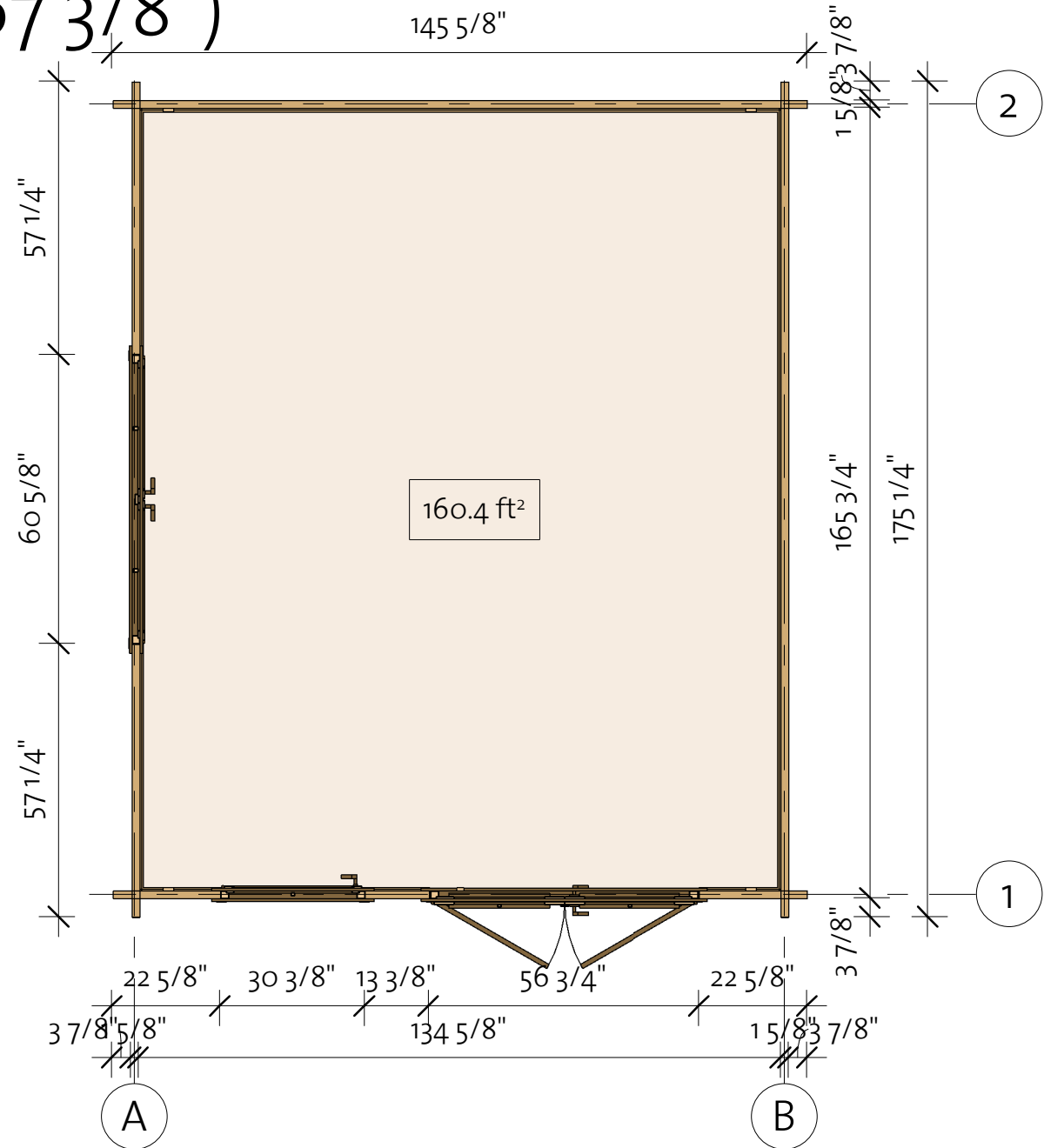

Kansas 40 (137 3/4" x 167 3/8")

Wall 1

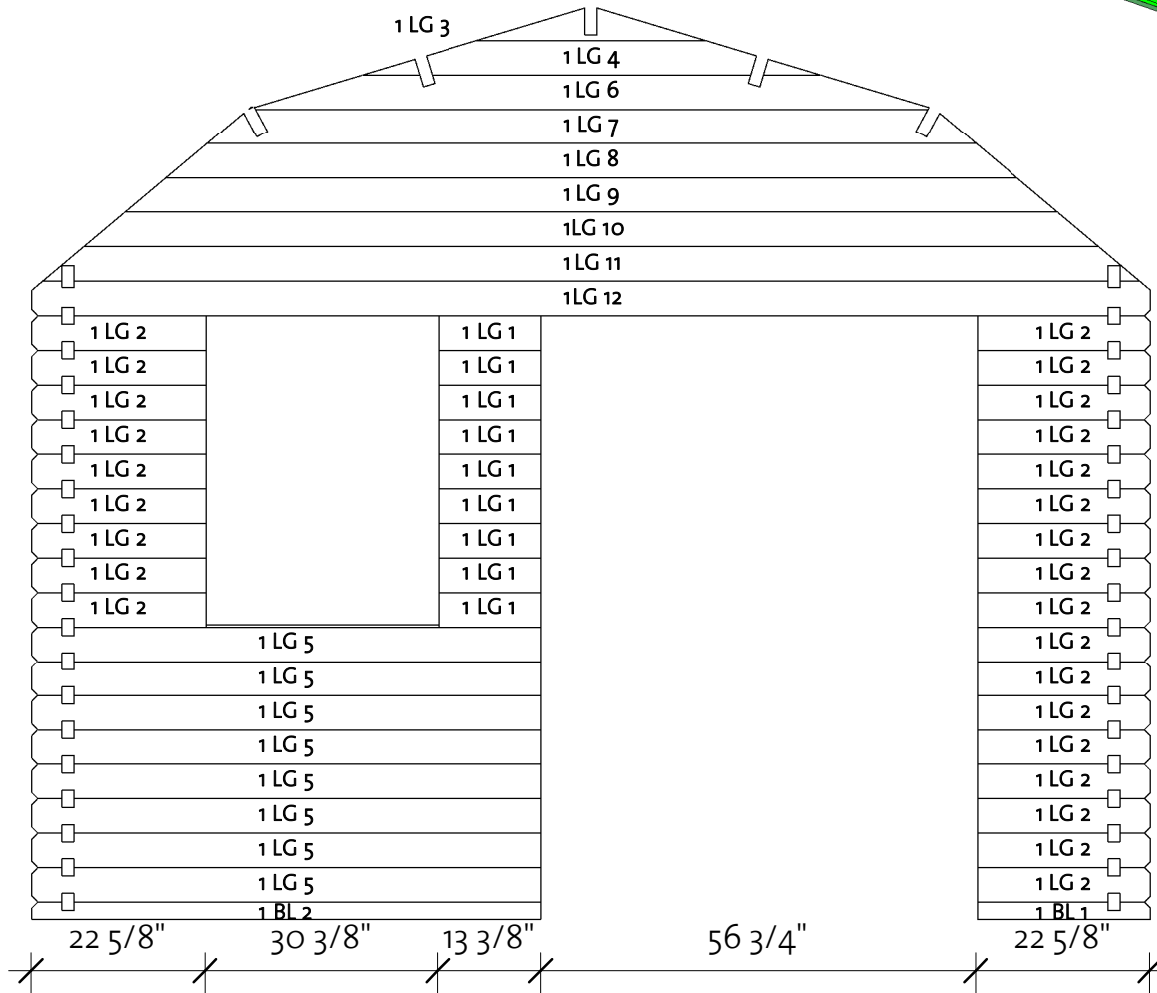
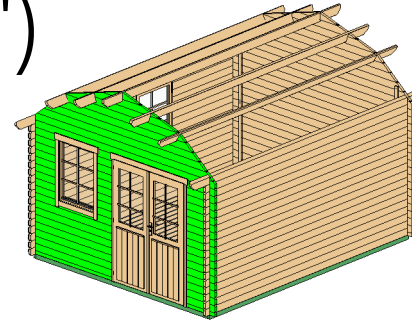

*Gable 1 - delivered premounted
 **Gable 2 - delivered premounted

Wall 1			
Mark	Profile	Count	Cut Length

1BL 1	40X57	1	22 5/8"
1BL 2	40X57	1	66 3/8"
1LG 1	40X114	9	13 3/8"
1LG 2	40X114	26	22 5/8"
1LG 3*	40X114	1	29 3/4"
1LG 4*	40X114	1	59 5/8"
1LG 5	40X114	8	66 3/8"
1LG 6*	40X114	1	87 3/4"
1LG 7*	40X114	1	100"
1LG 8**	40X114	1	110 3/4"
1LG 9**	40X114	1	121 1/2"
1LG 10**	40X114	1	132 1/8"
1LG 11**	40X114	1	142 7/8"
1LG 12**	40X114	1	145 5/8"

Log Profile Wall 1	
Profile	Profile

40X57	
40X114	

Kansas 40 (137 3/4" x 167 3/8")

Wall 2

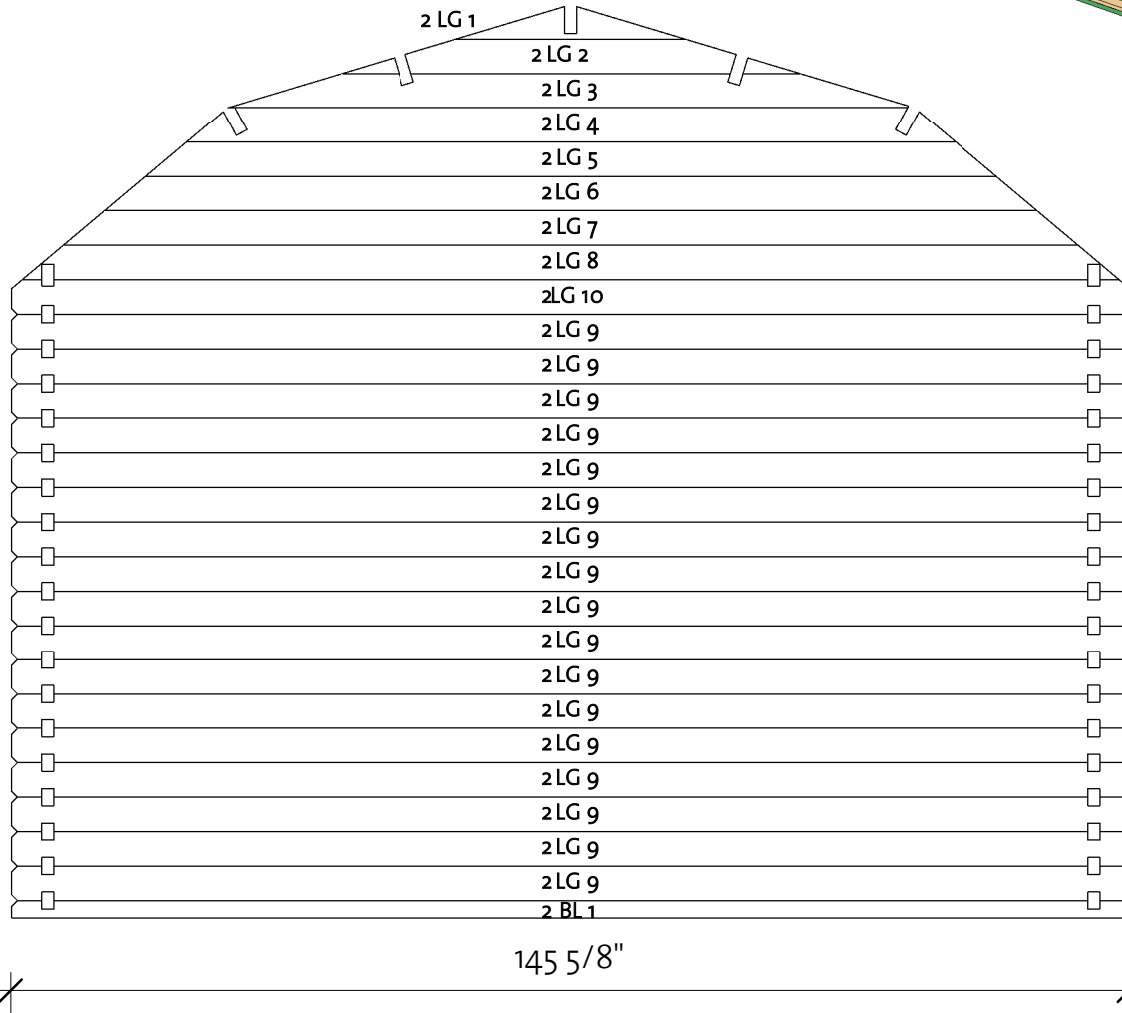
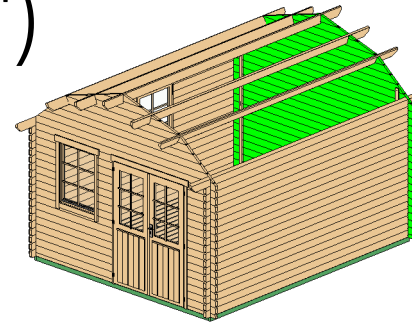

*Gable 1 - delivered premounted

**Gable 2 - delivered premounted

Wall 2			
Mark	Profile	Count	Cut Length

2BL 1	40X57	1	145 5/8"
2LG 1 *	40X114	1	29 3/4"
2LG 2 *	40X114	1	59 5/8"
2LG 3 *	40X114	1	88 5/8"
2LG 4 *	40X114	1	100"
2LG 5 **	40X114	1	110 3/4"
2LG 6 **	40X114	1	121 1/2"
2LG 7 **	40X114	1	132 1/8"
2LG 8 **	40X114	1	142 7/8"
2LG 9	40X114	17	145 5/8"
2LG 10 *	40X114	1	145 5/8"

Log Profile Wall 2	
Profile	Profile

40X57	
40X114	

Kansas 40 (137 3/4" x 167 3/8")

Wall A

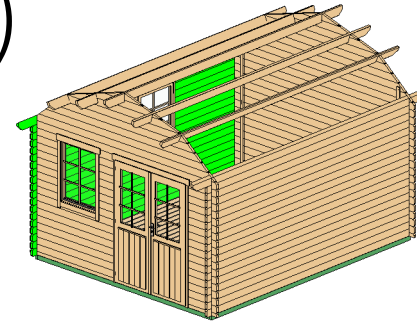

Wall A			
Mark	Profile	Count	Cut Length

ALG 1	40x114	18	57 1/4"
ALG 2	40x114	9	175 1/4"
ATL 1	40x145	1	198 7/8"

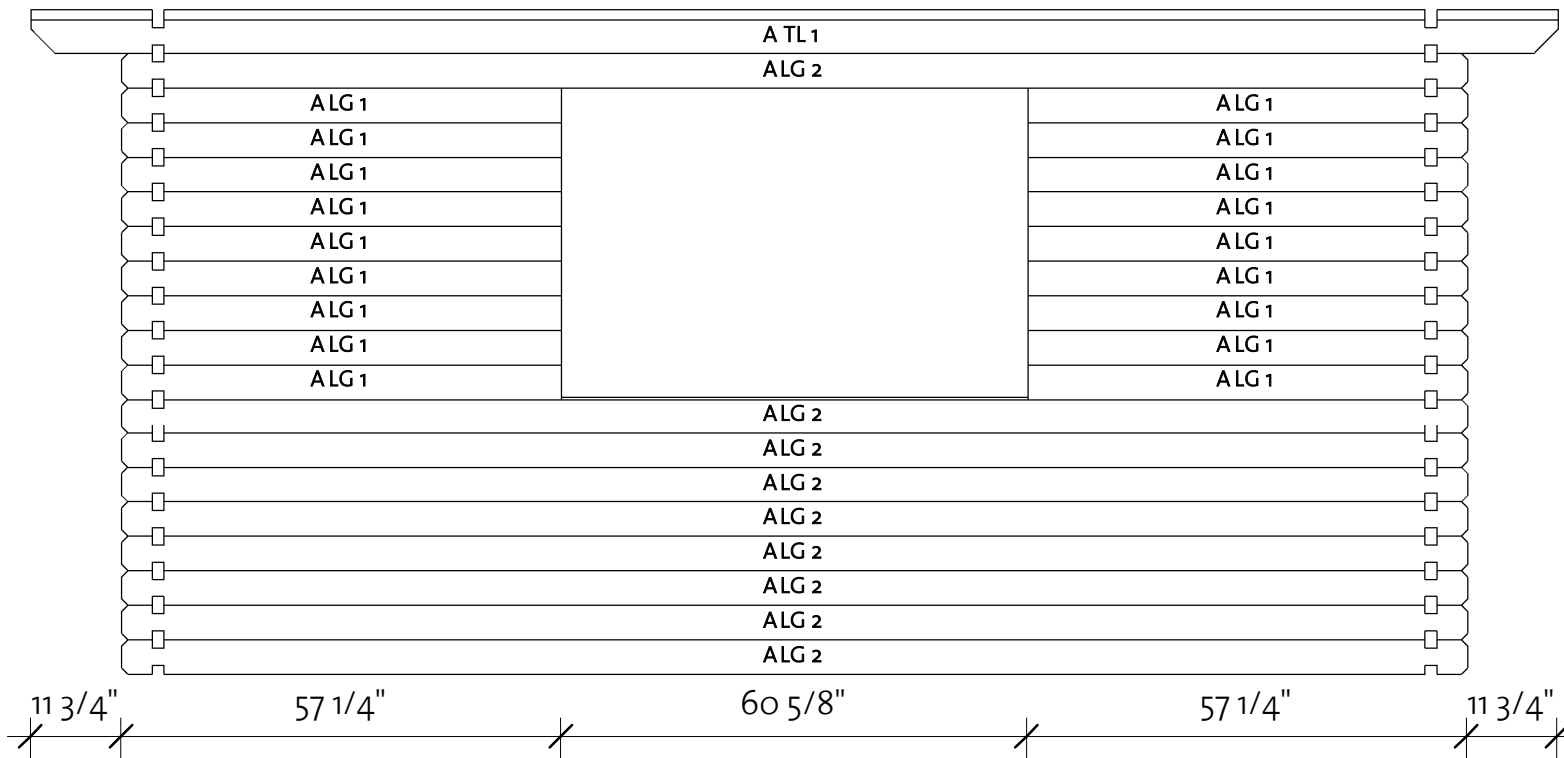

Log Profile Wall A	
Profile	Profile

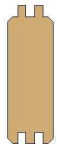
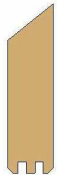
40x114	
40x145	

Kansas 40 (137 3/4" x 167 3/8")

Wall B

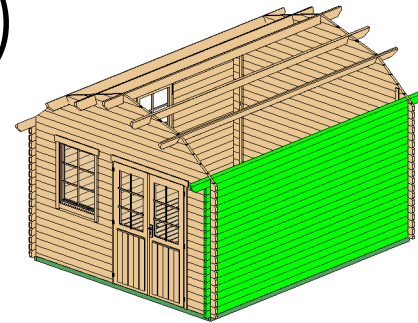

Wall B			
Mark	Profile	Count	Cut Length

BLG 1	40X114	18	175 1/4"
BTL 1	40X145	1	198 7/8"

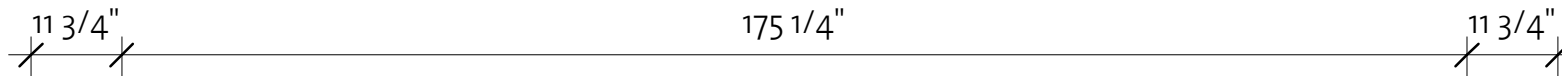
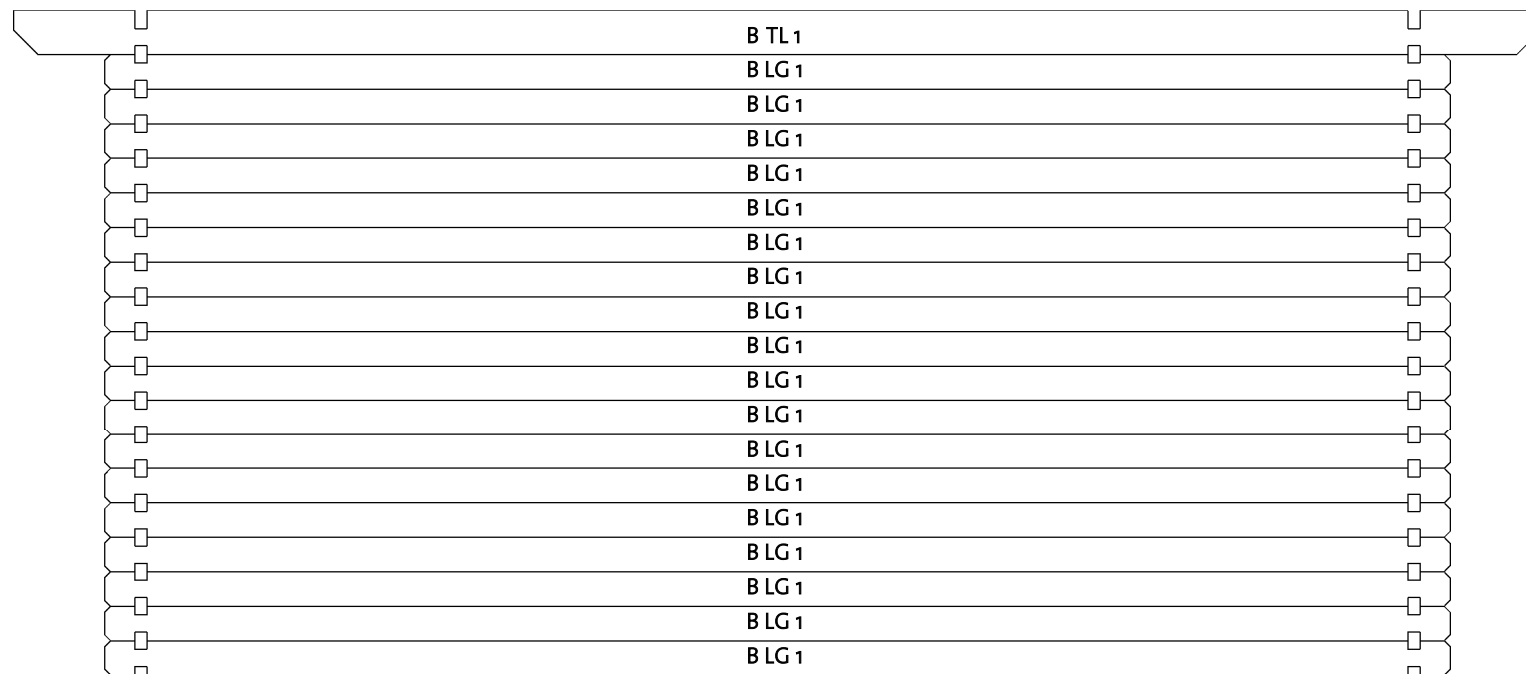

Log Profile Wall B	
Profile	Profile

40X114	
40X145	

Kansas 40 (137 3/4" x 167 3/8")

Roof 1

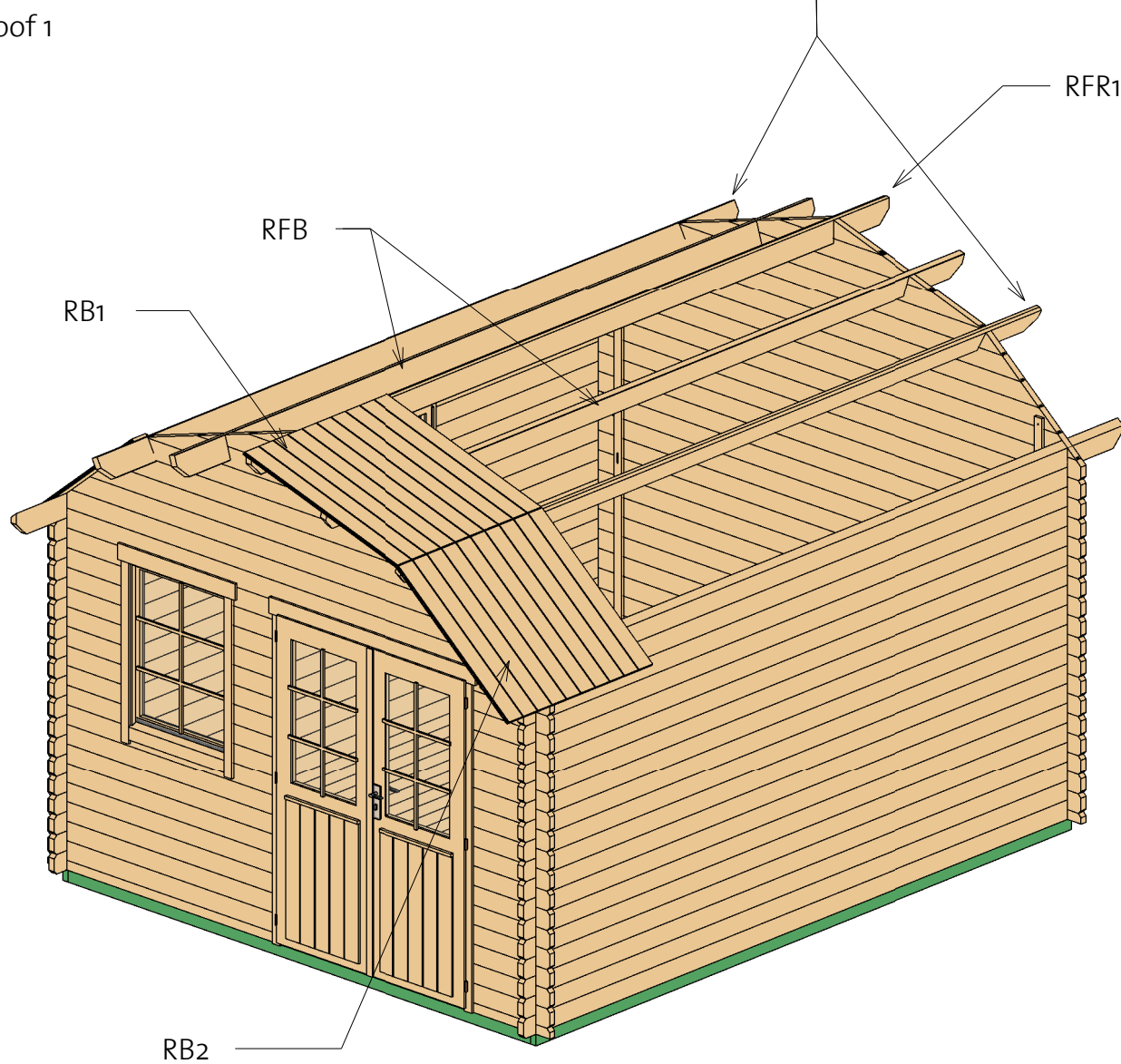

Roof				
Mark	Type	Profile	Count	Length
RFR1	Ridge 40x143		1	198 7/8"
RFR2	Ridge 40x143		1	198 7/8"
RFB	Beam 40x143		2	198 7/8"
RB1	17x114		92	46 5/8"
RB2	17x114		92	41 3/4"

Kansas 40 (137 3/4" x 167 3/8")



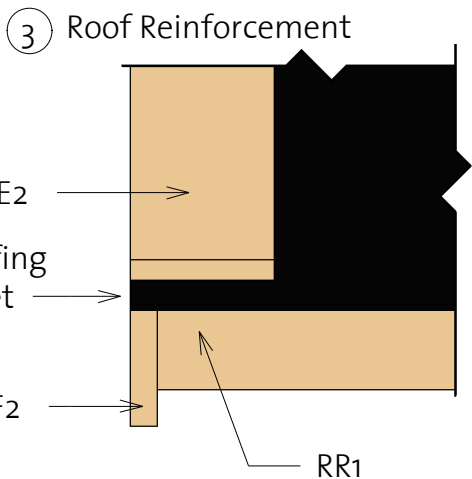
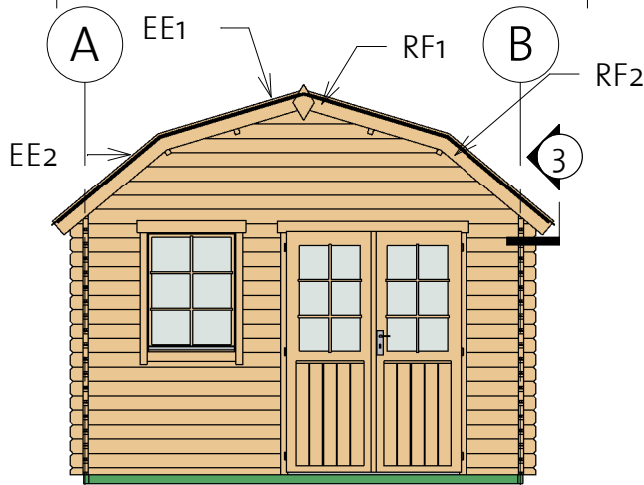
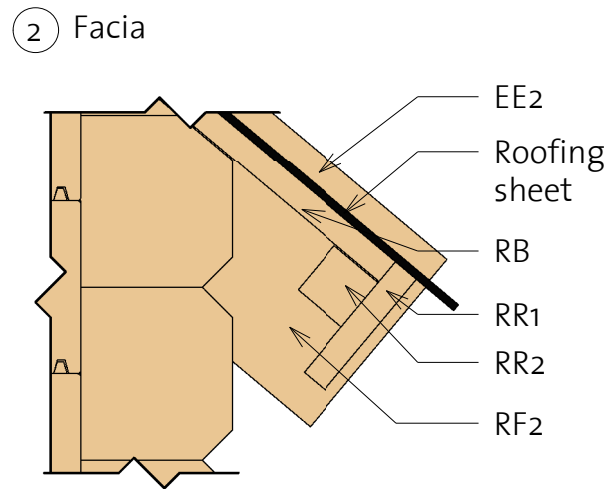
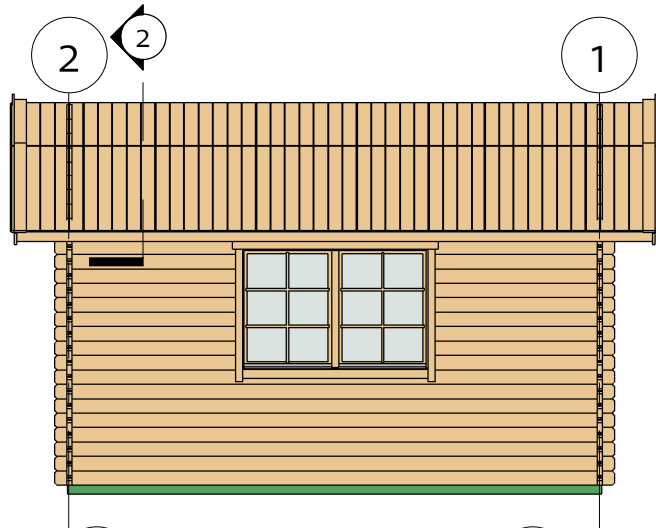





















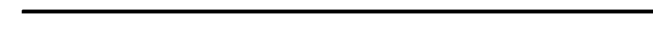



Roof 2

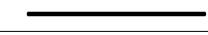

Fascia Schedule				
Mark	Type	Profile	Count	Length
EE1	Eave Edging 18x95		4	47 1/8"
EE2	Eave Edging 18x95		4	42 7/8"
RF1	Roof Fascia 18x120		4	47"
RF2	Roof Fascia 18x120		4	42 7/8"
RR1	Roof reinforcement 18x95		2	198 7/8"
RR2	Roof reinforcement 38x38		2	198 7/8"







Kansas 40 (137 3/4"x167 3/8")

List of all items 1

	RFB	Beam 40x143			2	198 7/8"
	RFR1	Ridge 40x143			1	198 7/8"
	RFR2	Ridge 40x143			1	198 7/8"
	RFR2	Ridge 40x143			1	198 7/8"
A	TL 1	Log 40x145			1	198 7/8"
B	TL 1	Log 40x145			1	198 7/8"
B	LG 1	Log 40x114			18	175 1/4"
A	LG 2	Log 40x114			9	175 1/4"
	IFB1	IFB 40x70			2	166 7/8"
	FB	FB 17x114			31	164"
2	BL 1	Log 40x57			1	145 5/8"
2	LG 9	Log 40x114			17	145 5/8"
	IFB2	IFB 40x70			9	134 1/4"
1	BL 2	Log 40x57			1	66 3/8"
1	LG 5	Log 40x114			8	66 3/8"
A	LG 1	<varies>			18	57 1/4"
	RB1	17x114			92	46 5/8"
	RB2	17x114			92	41 3/4"
1	BL 1	Log 40x57			1	22 5/8"
1	LG 2	<varies>			26	22 5/8"
1	LG 1	Log 40x114			9	13 3/8"

Kansas 40 (137 3/4" x 167 3/8")

List of all items 2

RR1	Roof reinforcement 18x95		2	198 7/8"
RR2	Roof reinforcement 38x38		2	198 7/8"
EE1	Eave Edging 18x95		4	47 1/8"
RF1	Roof Fascia 18x120		4	47"
EE2	Eave Edging 18x95		4	42 7/8"
RF2	Roof Fascia 18x120		4	42 7/8"

① Gable 1a

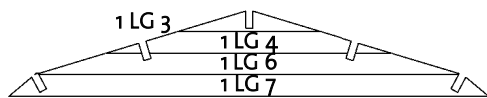

③ Gable 2a

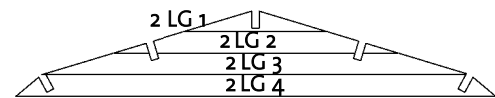





② Gable 1b

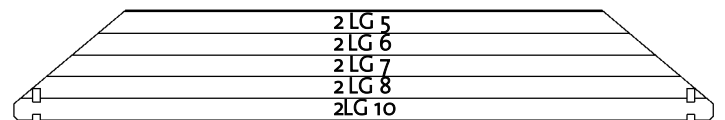







④ Gable 2b



BB1	BB 20x40			2	167 3/8"	
BB2	BB 20x40		1/4"	2200	2	137 3/4"
	Windboard 18x40					

Romb	2
------	---

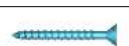

Hitblock	300-400 mm		
Bolts	M8 x 70		16
Screws	5,0 x 70		15
Nails	1,4 x 40		30
Screws	6,0 x 140		70
Screws	4,0 x 40		970

CDD1R	Classic double door 1 right	56 1/8"	77"	1
-------	-----------------------------	---------	-----	---

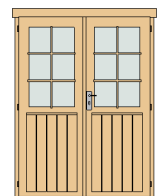

DCB6	Door crossbar 6	--	--	2
------	-----------------	----	----	---

CDW1	Classic double window 1	60 1/4"	39"	1
------	-------------------------	---------	-----	---

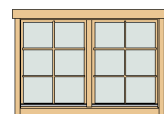

CW1R	Classic window 1 right	30 1/8"	39"	1
------	------------------------	---------	-----	---

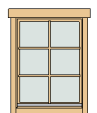

WCB6	Window crossbar 6	--	--	3
------	-------------------	----	----	---

4200011_200206